

AMBIENTAL ZEUS 1

IDLUX
ILUMINACIÓN LED

24LED

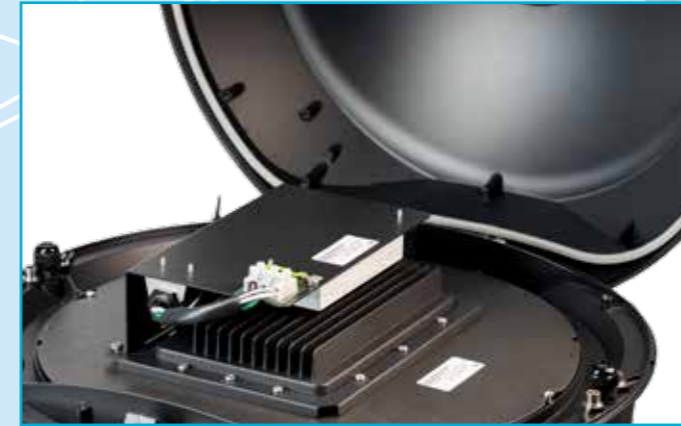
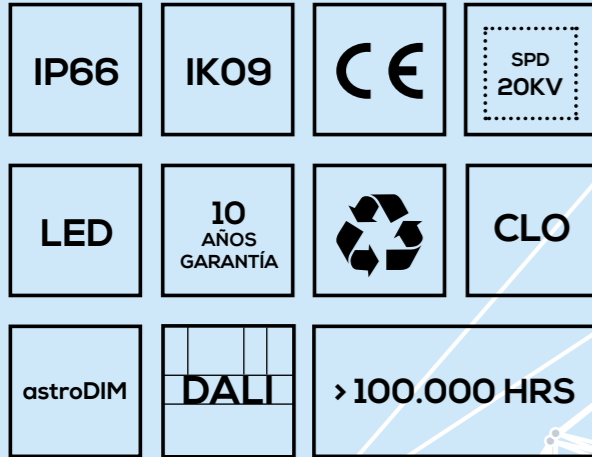

CARACTERÍSTICAS

- IP66
- IK09
- LED OSRAM
- CRI > 70
- ≥ 130 Lum/W
- TENSIÓN DE ENTRADA: 220-240V 50/60Hz
- FACTOR DE POTENCIA: > 0,9
- FUNCIÓN CLO: CONSTAN LUMEN
- FUNCIÓN ASTRODIM: REGULACIÓN DE NIVELES
- PROTECTOR SOBRETENSIONES 20kV DE SERIE
- VIDA ÚTIL > 100.000H
- 10 AÑOS DE GARANTÍA (*)
- CUERPO EN FUNDICIÓN DE ALUMINIO + CRISTAL TEMPLADO EXTRATRANSARENTE
- APLICACIONES: iluminación vial, residencial, urbanizaciones...

ESPECIFICACIONES 24LED

CONSULTAR OTRAS TEMPERATURAS DE COLOR
OTRAS POTENCIAS BAJO PEDIDO
TODOS LOS PARÁMETROS LUMÍNICOS, ELÉCTRICOS Y TÉRMICOS TENDRÁN UNA TOLERANCIA DE $\pm 5\%$

REFERENCIA	DESCRIPCION									
IDL-ZEUS-2450-NW4	AMBIENTAL ZEUS	50W	3700-4200K	6500Lum	CLO	ASTRODIM	20KV	IP66	IK09	
IDL-ZEUS-2455-NW4	AMBIENTAL ZEUS	55W	3700-4200K	7150Lum	CLO	ASTRODIM	20KV	IP66	IK09	
IDL-ZEUS-2460-NW4	AMBIENTAL ZEUS	60W	3700-4200K	7800Lum	CLO	ASTRODIM	20KV	IP66	IK09	
IDL-ZEUS-2465-NW4	AMBIENTAL ZEUS	65W	3700-4200K	8450Lum	CLO	ASTRODIM	20KV	IP66	IK09	
IDL-ZEUS-2470-NW4	AMBIENTAL ZEUS	70W	3700-4200K	9100Lum	CLO	ASTRODIM	20KV	IP66	IK09	

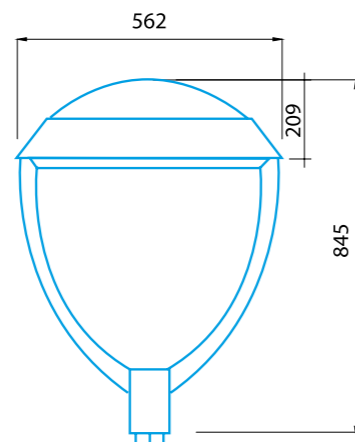

FOTOMETRÍA

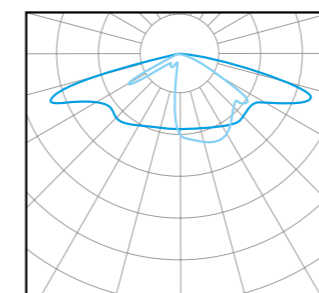

CD/KLM
— C0 - C180 — C90 - C270

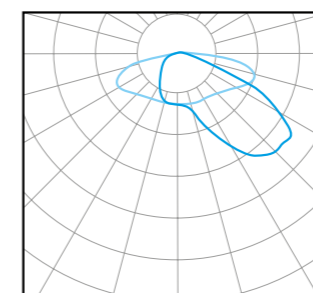

CD/KLM
— C0 - C180 — C90 - C270

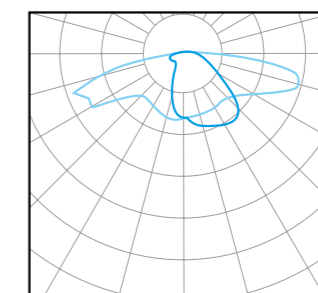

CD/KLM
— C0 - C180 — C90 - C270

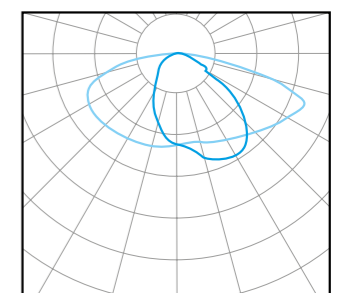

CD/KLM
— C0 - C180 — C90 - C270

AMBIENTAL ZEUS 1

IDLUX
ILUMINACIÓN LED

16LED

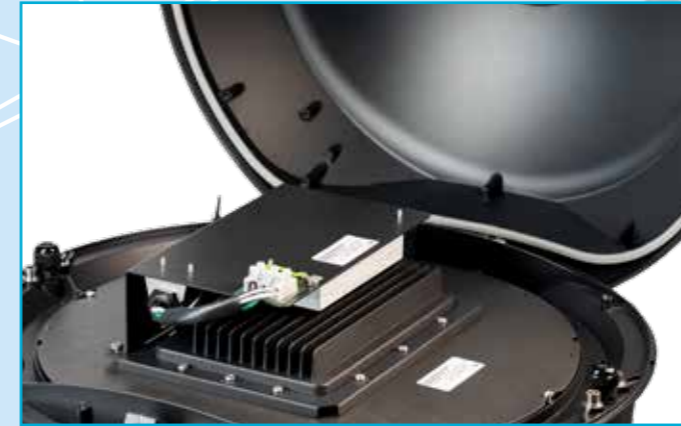
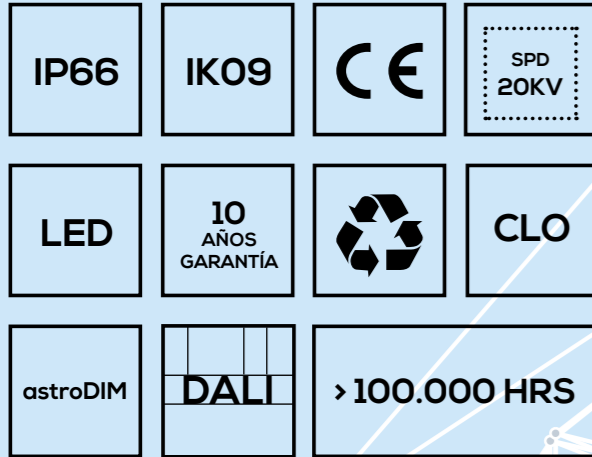

CARACTERÍSTICAS

- IP66
- IK09
- LED OSRAM
- CRI > 70
- ≥ 130 Lum/W
- TENSIÓN DE ENTRADA: 220-240V 50/60Hz
- FACTOR DE POTENCIA: > 0,9
- FUNCIÓN CLO: CONSTAN LUMEN
- FUNCIÓN ASTRODIM: REGULACIÓN DE NIVELES
- PROTECTOR SOBRETENSIONES 20kV DE SERIE
- VIDA ÚTIL > 100.000H
- 10 AÑOS DE GARANTÍA (*)
- CUERPO EN FUNDICIÓN DE ALUMINIO + CRISTAL TEMPLADO EXTRATRANSARENTE
- APLICACIONES: iluminación vial, residencial, urbanizaciones...

ESPECIFICACIONES 16LED

CONSULTAR OTRAS TEMPERATURAS DE COLOR
OTRAS POTENCIAS BAJO PEDIDO
TODOS LOS PARÁMETROS LUMÍNICOS, ELÉCTRICOS Y TÉRMICOS TENDRÁN UNA TOLERANCIA DE $\pm 5\%$

REFERENCIA	DESCRIPCION									
IDL-ZEUS-1620-NW4	AMBIENTAL ZEUS	20W	3700-4200K	2600Lum	CLO	ASTRODIM	20KV	IP66	IK09	
IDL-ZEUS-1625-NW4	AMBIENTAL ZEUS	25W	3700-4200K	3250Lum	CLO	ASTRODIM	20KV	IP66	IK09	
IDL-ZEUS-1630-NW4	AMBIENTAL ZEUS	30W	3700-4200K	3900Lum	CLO	ASTRODIM	20KV	IP66	IK09	
IDL-ZEUS-1635-NW4	AMBIENTAL ZEUS	35W	3700-4200K	4550Lum	CLO	ASTRODIM	20KV	IP66	IK09	
IDL-ZEUS-1640-NW4	AMBIENTAL ZEUS	40W	3700-4200K	5200Lum	CLO	ASTRODIM	20KV	IP66	IK09	
IDL-ZEUS-1645-NW4	AMBIENTAL ZEUS	45W	3700-4200K	5850Lum	CLO	ASTRODIM	20KV	IP66	IK09	

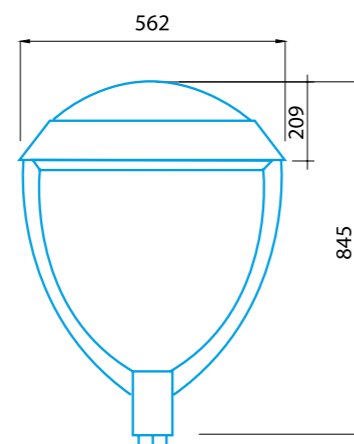

FOTOMETRÍA

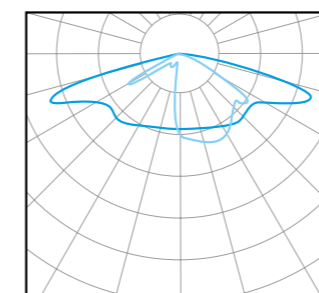

CD/KLM
— C0 - C180 — C90 - C270

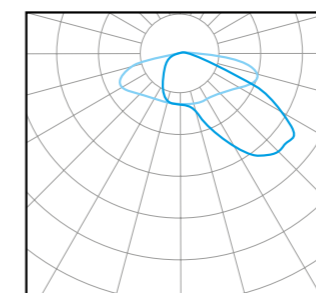

CD/KLM
— C0 - C180 — C90 - C270

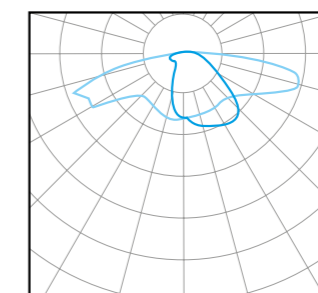

CD/KLM
— C0 - C180 — C90 - C270

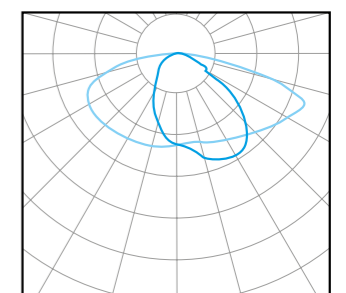

CD/KLM
— C0 - C180 — C90 - C270